

Digital Home Theater Receiver

RX-Z9

Yamaha introduces a new benchmark for receiver performance: the RX-Z9.

This flagship model goes beyond the capabilities of previous high-end Yamaha models with High-Definition CINEMA DSP technology, the ability to automatically optimize the sound for the listening room, superior audio and video quality, and the operating ease that Yamaha is famous for. The high end just moved up a step.



The RX-Z9 not only delivers the highest level of sound quality — it automatically optimizes the sound for the room!

If this receiver doesn't have it, you don't need it! A huge array of features and connections make the RX-Z9 the world's most versatile and enjoyable receiver.

The RX-Z9 is an Audiophile's Delight

The RX-Z9 has all the features a dedicated audiophile could want, and then some! Naturally, you get all the benefits of Yamaha's industry-leading CINEMA DSP technology, available in a broad selection of 51 surround programs with 71 variations. SILENT CINEMA allows surround sound to be heard through headphones. The all-new YPAO (Yamaha Parametric Room Acoustic Optimizer) functions as a high-end parametric equalizer to automatically analyze the room acoustics and optimize the sound output to match. A wide range of audio and video functions are provided, and the user-friendly GUI display offers an extensive choice of useful menus.

- 9.1-channel, 1,290W powerful surround sound (170W x 7 + 50W x 2)
- Digital ToP-ART (Total Purity Audio Reproduction Technology) and High Current Amplification
- Pure Direct mode for high quality 2-channel sound reproduction
- i.LINK digital audio interface for SACD/DVD-Audio
- Heavy-duty, rigid chassis symmetric construction with separate chambers and finest parts used throughout
- High-Definition* CINEMA DSP by powerful 32-bit Yamaha LSIs (YSS-930 x 4)
 - * Double the speed and triple the density compared to previous processing system
- Compatibility with latest movie sound formats including Dolby Digital EX, Dolby Pro Logic II, DTS-ES Discrete 6.1, DTS Neo:6 and DTS 96/24
- THX Ultra2 Processing
- 51 surround programs (71 variations) with SILENT CINEMA and Night Listening mode
- 192 kHz/24-bit D/A converter for all channels
- Digital component video up conversion
- Progressive Scan Output, Noise Shaped Video, DCDi, TrueLife Enhancer
- YPAO (Yamaha Parametric Room Acoustic Optimizer)
- On-Screen Display with GUI (Graphic User Interface)
- Custom installation compatibility with RS-232C and remote control IR code

RX-Z9

Digital Home Theater Receiver



DIGITAL ToP·ART

Total Purity
Audio Reproduction Technology

From digital input, through digital processing,
to amplification, maximum signal quality is maintained
every step of the way.

Digital ToP-ART (Total Purity Audio Reproduction Technology) is the name Yamaha has given to a design philosophy whose goal is to maximize digital quality while minimizing analog circuitry. The culmination of the best digital engineering and design possible today, it brings together several key elements to create the best-sounding, easiest-to-use A/V components available. In the RX-Z9, Digital ToP-ART can be divided into three categories.

- 1** High Performance Digital Circuitry with Burr-Brown 24-bit BiCMOS Sign-Magnitude DACs for all 11 output channels and an Accurate Touch Volume Control with 99dB range.
- 2** High-Definition CINEMA DSP Circuitry with the new powerful 32-bit floating point LSIs (YSS-930 x 4).
- 3** High Current Amplification with low-impedance design, superior toroidal transformer, gigantic heat sinks and many other advantages.

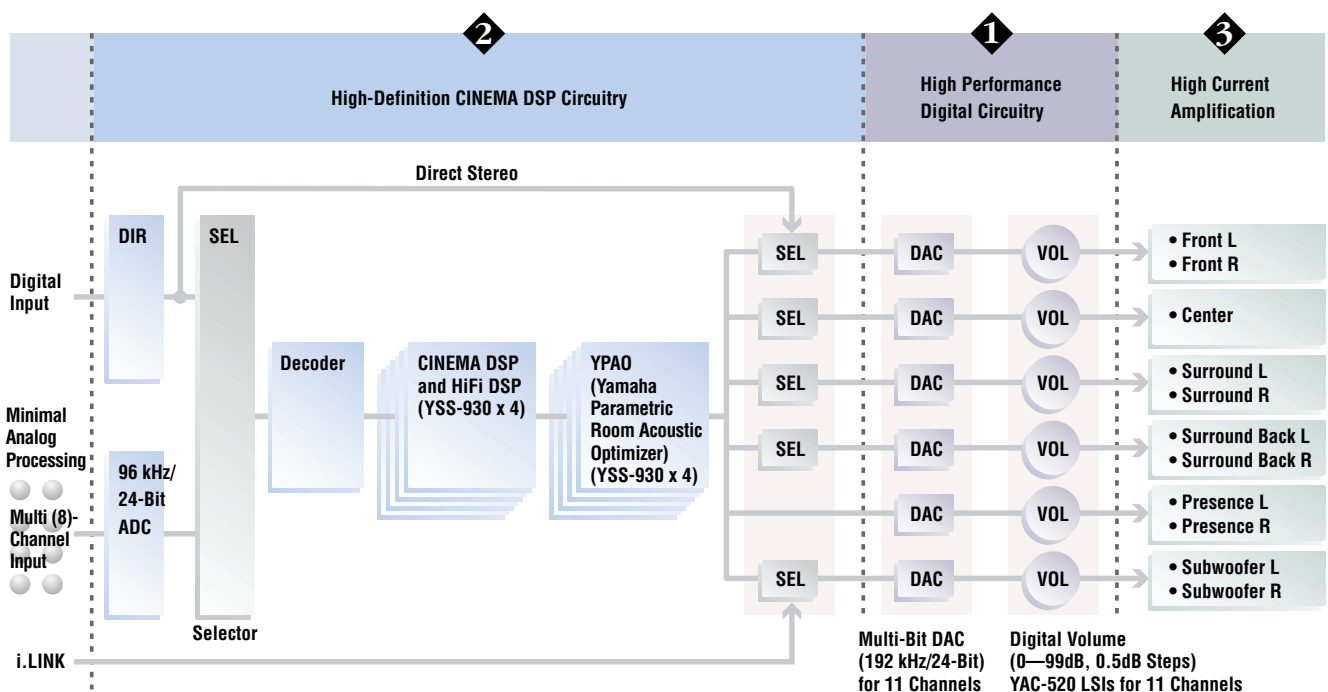

The RX-Z9 not only delivers the highest level of sound quality



High Performance Digital Circuitry

The RX-Z9 employs a wide array of sophisticated technology, beginning with Burr-Brown 192-kHz/24-bit digital-to-analog converters for all 11 channels with DSD (Direct Stream Digital) compatibility. An Accurate-Touch Volume Control is also used for all channels (Yamaha YAC520 LSIs). The digital bass/treble tone controls have turnover frequencies for main L/R and center channels. 8-channel analog input signals are processed by 192kHz A/D conversion for high sound quality (1-bit direct conversion for SACD and DVD-Audio). All circuitry is on a 4-layer processing board with fully shielded cabinet for reduced digital interference. The receiver also offers i.LINK (IEEE1394) compatibility.

Choice of Signal Paths for Higher Sound Quality

The RX-Z9 provides a choice of five specialized signal paths for obtaining the purest signal quality possible.



Burr-Brown 192 kHz/24 Bit PCM1792 DACs

The PCM1792 is a high-performance, precision 24-bit BiCMOS Sign-Magnitude DAC with ultra-low distortion of only 0.0008% (K-grade THD + N) and S/N ratio of 120dB. It offers superior low level linearity, with excellent full-scale performance under varying operating conditions. Its major benefit is performing accurate sound field reproduction for high quality multi-channel reproduction such as Dolby Digital and DTS.

Pure Direct provides the shortest possible signal path for 2-channel or multi-channel analog inputs, with no signal processing and no display. Straight outputs the original analog or digital signal without any post-processing. Direct Stereo provides a direct connection for stereo input,

with a dimmed display. 2-Channel Stereo processes the multichannel signal and outputs it via 2-channels, for those with a two-speaker system. And the iLink connection is for multi-channel digital music signals (DVD-Audio and SACD).

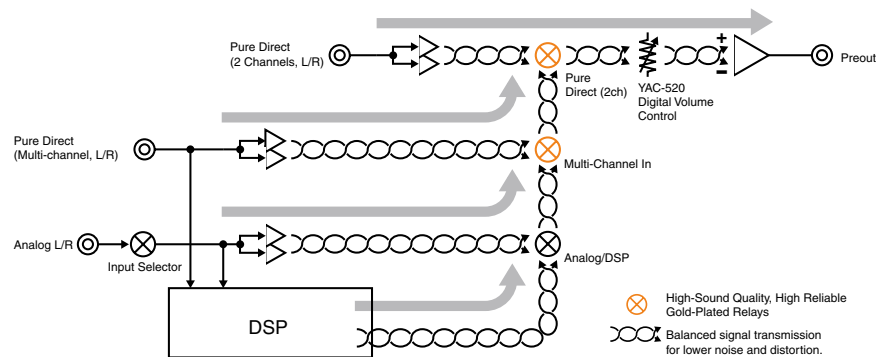

RX-Z9 Front Channel Signal Flow

RX-Z9 Operation Difference

	Pure Direct	Straight	Direct Stereo
Operation	Front Panel	Front Panel & Remote	Program
Source	2-Ch Analog (Direct Input)/ Multi-Ch Analog	Analog & Digital	Analog & Digital (PCM)
A/D Conversion	—	Yes	No
Decoder	—	Yes	No
Post Processing	—	No	No (Bypass)
YPAO/Sp Configuration	—	Yes	No (Bypass)
YPAO/Tone Control	No	Yes	No
YPAO/Speaker Level	No	Yes	No
FL Display	Off	Yes	Dimmer

3 Front Operational Modes

Pure Direct: For pure analog audio enjoyment.

This mode provides the shortest signal path and eliminates as many control, processing and display functions as possible. It accepts SACD and DVD-Audio inputs.

Straight: For original channel audio

enjoyment without post-processing. This mode accepts both analog and digital sources, providing decoding but not post-processing. It can handle two-

channel and multi-channel sources, and the YPAO speaker configuration, tone control and speaker level functions are applicable.

Direct Stereo: For direct two-channel enjoyment.

This mode accepts two-channel analog and digital sources, bypassing the DSP and other processing circuits.

Note: Mode priority is in the above order.

— it automatically optimizes the sound for the room!

DIGITAL TOP·ART 2

High-Definition CINEMA DSP Circuitry

The RX-Z9 has six times greater DSP capacity than previous models, thanks to an increase from 48kHz A/D converters to 96kHz/24-bit types that can accept 96kHz analog signals for direct digital conversion and processing. Higher density processing enables approximately triple the amount of early reflection data to be handled, for significantly richer surround sound performance. The RX-Z9 also employs 192kHz/24-bit D/A conversion and DSP processing and Yamaha's 32-Bit Floating-Point Quantization System LSIs (YSS-930 x 4) for high precision decoding of Dolby Digital, DTS Digital Surround, DTS 96/24, DTS-ES Discrete 6.1, DTS-ES Matrix 6.1, DTS Neo:6 and Dolby Pro Logic II formats. There are 51 surround programs available, with 71 variations, including Quad-Field CINEMA DSP programs for 6.1-Channel Digital Surround. SILENT CINEMA for surround sound through headphones and Virtual CINEMA DSP for two-speaker systems are also included.

Even though CINEMA DSP has been the premier DSP technology in the world for the past few years,

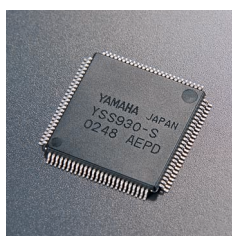

Yamaha's Exclusive YSS-930 32-Bit Floating Point Quantization LSI

This powerful LSI performs all Dolby Digital and DTS decoding with extreme

accuracy, as well as all digital sound field processing, capabilities that previously required two or more chips. It also outperforms other chips in the precise synchronization of images and sound.

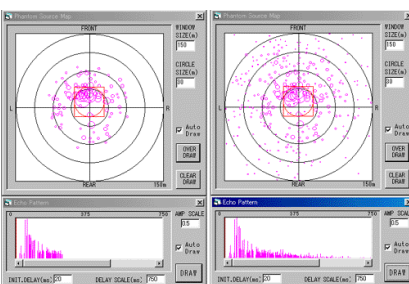
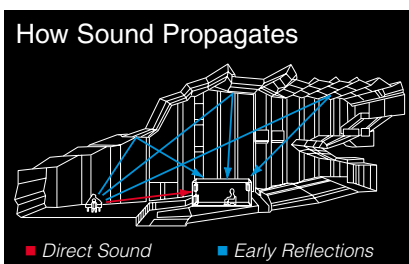

Previous DSP Technology

High-Definition DSP Technology

Yamaha has upgraded it in the RX-Z9. In fact, this receiver has 6 times greater DSP capacity than previous models, thanks to an increase from 48k to 98k signal capability and 3 times higher density early reflections, as shown in the above photos.

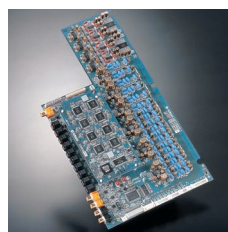

High-Definition CINEMA DSP Board

Accurate Touch Volume Control

No one expects more from a volume control than up and down — except Yamaha. We decided that controlling the volume could be made both easier and more accurate, and the result is the Accurate Touch Volume Control. It lets you make delicate adjustments within a narrow range, yet enables you to move to very high or low levels more quickly. Its extreme accuracy is due to

a high-signal-resolution analog design in conjunction with an ultra-precise digital control circuit (Yamaha original YAC-520 LSIs) for all



Digitally Regulated Volume Control Device (Yamaha Original YAC-520 LSI)

channels. The wide control range extends from -80dB to $+16.5\text{dB}$, with narrow 0.5dB steps throughout the entire range for delicate control, even at low volumes.

4-Layer DSP Processing Board

All of the DSP IC chips and related circuitry are located together on a 4-layer board, which provides a number of advantages. The dimensions are smaller (2/3 previous types), so signal paths are shorter and there is more space for the large power supply components. Digital interference is reduced and impedance is lower as well.

Accurate, Adjustable Lip-Sync

The YSS-930 LSI in the RX-Z9 provides accurate synchronization of images and sound, known as "lip-sync." Most audio LSIs do not have the necessary speed and precision to handle this, but with the YSS-930, not only has accurate lip-sync been achieved, but its parameters can be adjusted by the user.

Digital Tone Controls

Digital tone controls are provided for left, right and center channels, allowing a much greater degree of control over the front sound field.

High Current Amplification Achieves Low Impedance/High



The Importance of High Current

Although power rating is often the first thing people look at in a receiver, high power output does not necessarily mean good sound. High current level is a much more important factor. Yamaha receivers has always had fairly high current levels, but with the RX-Z9, we have further improved this performance.

What It Does

In brief, Yamaha High Current Amplification achieves low impedance, high current power from input (power supply circuit) to output (speaker terminals). This drives the speakers much more smoothly and dynamically, for better sound from all sources, including 2-channel audio.

Specific Improvements

The first problem to be overcome was

the difference in voltage that ordinary receivers suffer between the power supply and amplifier circuits, caused by current fluctuations. This was solved by using custom-made, high-grade block electrolytic capacitors and a copper grip for one-point grounding. Another current drop is generally seen between the amplifier circuit and the speaker terminals, caused by the cables, speaker output relays, copper circuit boards, and so on. To increase current here, we used an extra-large, low-impedance transformer and gold-plated speaker relay contacts.

9-Channel High Power, Discrete Amplifier Configuration

The RX-Z9 delivers a huge 170W to each of seven channels (two front, one center, two surround and two surround back), as well as 50W to the two presence (front

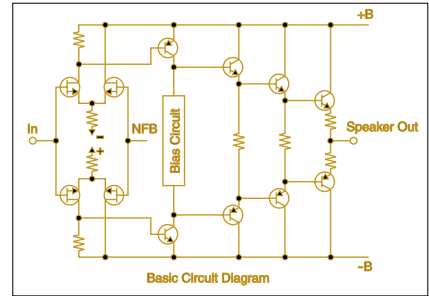

Symmetrical power amplifier circuit configuration results in improved slew rate and balanced clipping.

effect) channels. This is more than enough to fill even the largest rooms with vibrant music and Richter-scale sound effects. 6-4 mixdown is also provided, for enjoying 6-channel input sources from four or five speakers you already have on hand with or without subwoofer. And also The high current amplification system uses symmetrical drive and a full push-pull circuit configuration with a complementary FET input stage. A large toroidal transformer and large capacity block chemical condenser (28,000 μ F) ensure a stable power supply.

High Current Amplification Principle

The voltage (A) of Block Electrolytic Capacitors and voltage (B) of Power Transistor Collector should be ideally at the same level. However, when the current become large, there will be a big difference in the level of each voltages.

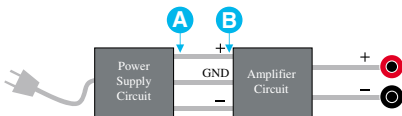

Voltage level difference between A (power supply circuit) and B (amplifier circuit).

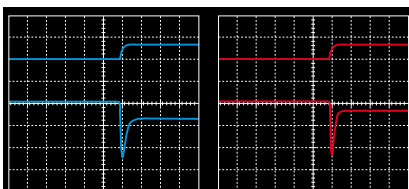

Conventional Amplifier High Current Amplification

There is also a level difference between Output of the Power Amplifier (C) and Speaker Terminals (D), which is reflected by coppers of PCB, Speaker output relays, cables and so on, resulting damaging the sound quality.

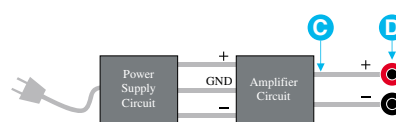

Voltage level difference between C (amplifier circuit output) and D (speaker terminals).

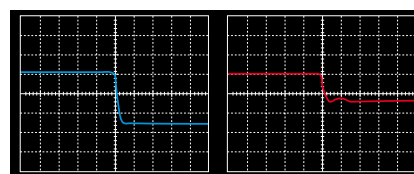

Conventional Amplifier High Current Amplification

High Dynamic Power Capability

The RX-Z9 is capable of delivering large amounts of reserve power for accurate reproduction of the high energy peaks that are especially prevalent in digital audio sources. This emphasizes the music's dynamic qualities and provides a sharper sound image.

Linear Damping

Level variations due to high amp impedance tend to reduce an amplifier's damping factor, and frequency variations cause it to fluctuate. This circuit cancels the effect of these variations, maintaining a high, stable damping factor, for superior articulation

Current Power from Input to Output.

of all sounds and better frequency response.

Super High Grade Construction and Finest Parts Used Throughout

The RX-Z9 uses a heavy-duty, rigid chassis construction with separate chambers for individual sections to prevent any internal interference. The chassis also has electromagnetic shielding. Large, anti-resonance, aluminum-extruded heat sinks provide effective heat dissipation. Supporting all this is Yamaha's ToP-ART base and ART (anti-resonance and tough) feet, which provide stability and complete vibration-damping. The speaker terminals are gold-plated, super-quality, 2-way binding post types.

In order to realize the goals of massive power and superlative sound quality, Yamaha technicians completely re-evaluated all the parts used in

previous receivers. As a result, many were replaced with more expensive or custom-designed units.

- Two Direct Signal Path Speaker Relays with Gold-Plated Crossover Connection and Shielding
- Thick PC Board Wiring with 1.6mm (5/8") ϕ Copper Jumper Cables
- High Sound Quality Schottky Barrier Diode for High Gain S/N Ratio
- High Performance FE Myca Capacitors and Metric Mylar Film Capacitors using Polypropylene Material
- Extra-Thick (100mm; 4") Aluminum-

- Extruded Front Panel
- Discrete Power Supply Configuration for All Channels

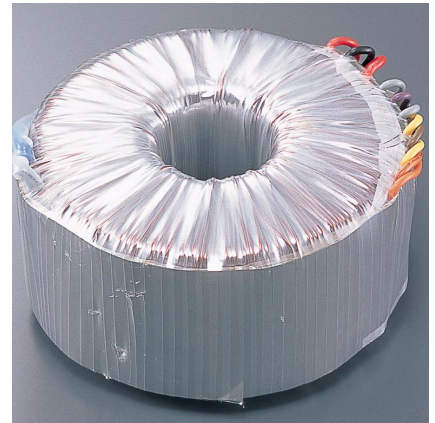

Extra-Large Toroidal Transformer

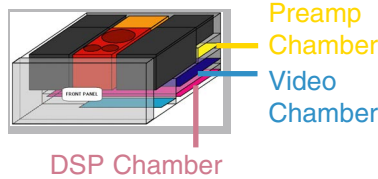

Gold-Plated-Extruded Gigantic Speaker Terminals

Power Amplifier (Left) with Large, Anti-Resonance, Aluminum-Extruded Heat Sink (Left) Providing Effective Heat Dissipation

Control Section

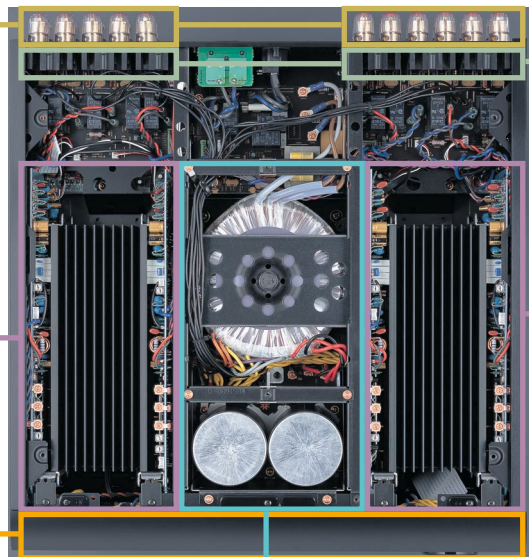

Two Direct Signal Path Speaker Relays with Gold-Plated Crossover Connection and Shielding
Power Amplifier (Right) with Large, Anti-Resonance, Aluminum-Extruded Heat Sink (Right) Providing Effective Heat Dissipation

Power Supply Chamber with Extra-Large Toroidal Transformer and Extra-Large Custom-Made Block Electrolytic Capacitors (28,000 μ F)



Extra-Large Custom-Made Block Electrolytic Capacitors (28,000 μ F)



Gold-Plated-Extruded Gigantic Speaker Terminals



Two Direct Signal Path Speaker Relays

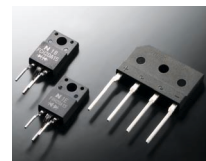

High Sound Quality Schottky Barrier Diode for High Gain S/N Ratio

Yamaha CINEMA DSP for Home Theater: Dramatically Different

Going Beyond Conventional Multi-Channel Systems



Conventional 5.1-channel/6.1-channel audio reproduction systems base their sound on Dolby Digital and DTS decoding, using matrix and steering technologies to create surround sound effects. Yamaha CINEMA DSP is much more advanced, actually creating richly realized independent sound fields that merge to envelop you in an unmatched surround sound experience. With dialogue, music and effects from the presence (front line), surround and surround back fields, you will hear sound with highly

accurate localization, smooth movement, exceptional clarity and richness, and startlingly realistic presence. It will seem as if the walls of your room have disappeared and you are in the middle of your own immense theater!

Quad-Field and Tri-Field CINEMA DSP

Tri-Field CINEMA DSP projects three sound fields into the home theater: a Presence sound field in the front and two Surround sound fields in the left rear and right rear, resulting in a powerfully realistic three-dimensional soundscape. And now Yamaha also offers Quad-Field CINEMA DSP. It adds an additional rear center sound

field to the Tri-Field system, in order to enjoy the new 6.1-channel formats, Dolby Digital EX and DTS-ES.

CINEMA DSP Programs

One of the main advantages of CINEMA DSP is the large choice of sound field programs available. The basic program for movies is Enhanced, which greatly improves the sound of the surround fields. The "largest" of these sound fields is Spectacle, which recreates the open feeling of large-scale, epic motion pictures. The Sci-Fi is designed to reproduce all the complex, dynamic sounds of space/science fiction movies. Adventure and General are also included.

RX-Z9 Surround Programs: 51 Surround Programs (71 Variations)

STEREO	● 2-Channel Stereo	
	● Direct Stereo	
HiFi DSP Programs Variations		
	● Munich A	1
	● Frankfurt	1
	● Stuttgart	1
CONCERT HALL 1	● Munich B	1
	● Vienna	1
	● Amsterdam	1
	● Hall G in U.S.A.	1
CONCERT HALL 2	● Hall H in U.S.A.	1
	● Live Concert	1
	● Tokyo	1
CHURCH	● Freiburg	1
	● Royaumont	1
	● Village Gate	1
JAZZ CLUB	● Village Vanguard	1
	● The Bottom Line	1
	● The Roxy Theatre	1
ROCK CONCERT	● Warehouse Loft	1
	● Arena	1
ENTERTAINMENT	● Disco	1
	● Party	1
9-CH STEREO	● 9-Channel Stereo	1
Program Subtotal	21	21

Remarks	
●	HiFi DSP Programs
●	A/V Programs
●	CINEMA DSP
●	Tri-Field CINEMA DSP Capable
●	Quad-Field CINEMA DSP Capable
●	All DSP programs are available in the SILENT CINEMA and Virtual CINEMA DSP modes.

CINEMA DSP Programs Variations	
ENTERTAINMENT	● Game 1
	● TV Sports 1
	● Mono Movie 1
	● Pop/Rock 1
	● DJ 1
MUSIC VIDEO	● Classical/Opera 1
	● Pavilion 1
	● Spectacle 5
MOVIE THEATER 1	● Sci-Fi 5
	● Adventure 5
MOVIE THEATER 2	● General 5
ENHANCED	● Enhanced 5
Program Subtotal	12 32
Decoder Straight Out Formats Variations	
	● Dolby Digital 1
	● Dolby Digital/ EX 1
	● DTS Digital Surround 1
	● DTS 96/24 1
	● DTS-ES Matrix 6.1 1
	● DTS 96/24 ES (6.1) 1
	● DTS-ES Discrete 6.1 1
	● Dolby Pro Logic 1
	● Dolby Pro Logic II Music 1
	● Dolby Pro Logic II Movie 1
	● DTS Neo:6 Music 1
	● DTS Neo:6 Cinema 1
Program Subtotal	12 12
THX Variations	
	● Cinema 1
	● Ultra 2 Cinema 1
	● Music 1
	● ES Matrix 6.1 1
	● ES Discrete 6.1 1
	● Surround EX 1
Program Subtotal	6 6
Program Total	51 71

Auto Priority Input Terminal Selection and Auto Decoder Selection

Digital input terminals are provided to handle any kind of digital input. Functions are programmed to select priority in order of coaxial digital, optical digital and analog when different digital formats are input from the same source. The sound decoder is also automatically selected and processed according to the combination of the format of input signals and the selected sound field programs, while DSP sound field processing is optimized at the same time.

Than Other Systems.

Night Listening Mode for All Surround Programs

When you're listening to movies late at night and turn down the volume during loud scenes, dynamic range suffers and you may miss some dialogue and other sounds. By engaging the Night Listening mode, you can reduce the volume and still enjoy proper tonal balance and dynamic range. You hear dialogue clearly and the music and action are just as exciting (without the screams and explosions disturbing others).

SILENT CINEMA and Virtual CINEMA DSP

The SILENT CINEMA mode gives you private listening enjoyment of

SILENT CINEMA™

multi-channel music or movie sound, including Dolby Digital and

DTS surround, through ordinary headphones. It's automatically selected when the headphones are plugged in. Virtual CINEMA DSP lets you enjoy the effects of CINEMA DSP surround sound without using rear speakers (handy for use in custom installations where some rooms don't have rear speakers). It can be used with the main/center/front effect speakers or even with just the two main left and right speakers.



SILENT CINEMA Sound Field Imaging

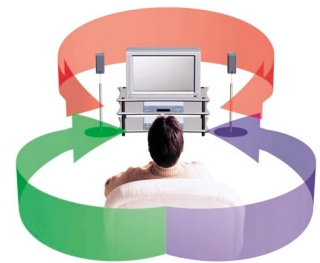

Conventional 6.1-Channel Systems



Quad-Field CINEMA DSP

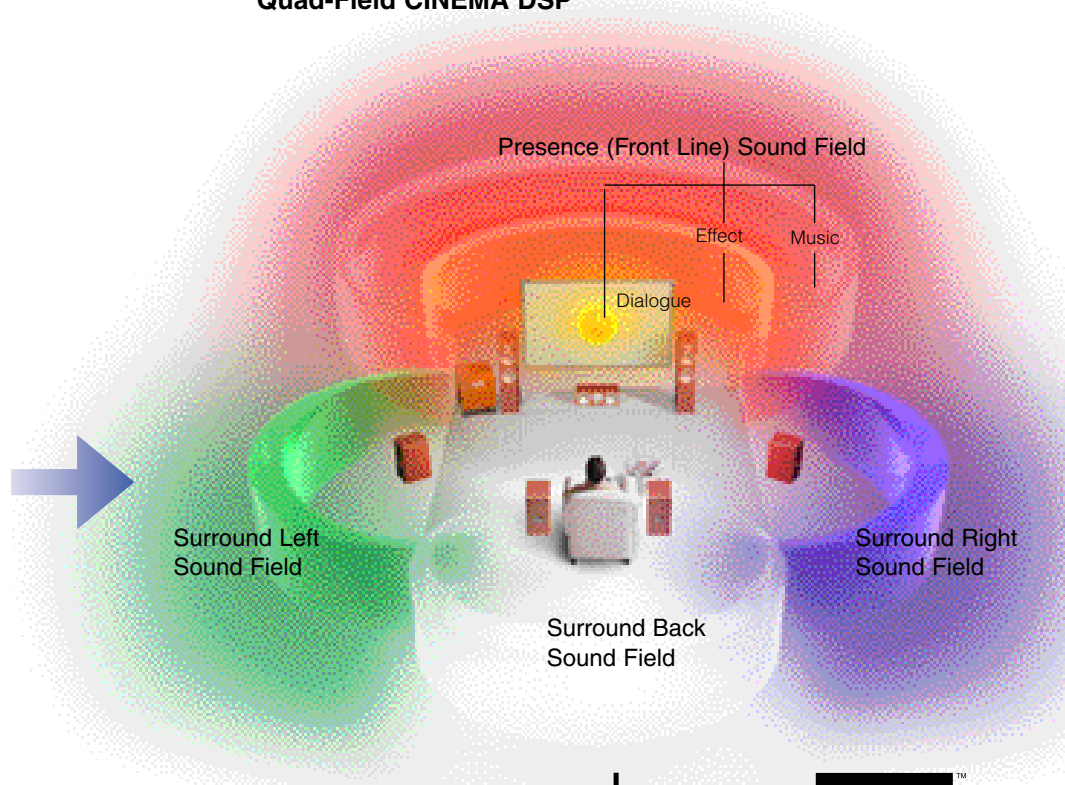

YPAO (Yamaha Parametric Room Acoustic Optimizer) and Easy

YPAO: The Best Sound for Your Room — Automatically!

This new capability is one of the RX-Z9's most innovative and appealing features. The receiver comes supplied with a small microphone, which the user places in the listening position. Activating the functions causes a test tone to be emitted, which is analyzed, and based on the results, the audio output is automatically adjusted to provide the optimum sound for the room acoustics. The optimizer functions as a parametric, not merely a graphic, equalizer, providing a degree of precision calibration that users could not do by themselves. Among the factors considered are speaker position, speaker connection, speaker size, channel level balance, speaker distance and speaker frequency response. In short,



RX-Z9 Optimizer Microphone

the RX-Z9 not only delivers better sound, it delivers the BEST sound for each and every room.

On-Screen Display with GUI (Graphic User Interface)

A handy GUI that includes extensive yet easily understandable setup menus makes it easy to select and adjust desired functions. Especially useful is a speaker display in the Speaker Test mode that makes it easy to balance



the levels of all speakers. DSP programs can be selected with the remote control so their effects can be judged from the listening position. A rotary encoder Input Selector makes source selection quick and easy.

Easy Setup and Operation

The RX-Z9 has an ergonomic design that ensures simple, convenient operation. Everything from the layout of the controls to the display menus has been planned to make using it easy and enjoyable. For even greater setup ease, a Basic Mode permits basic settings to be made without using the Setup menus and with a minimum of steps.

Program Name and Surround Sound Indications

The front panel display shows a variety of surround sound status indications, so you always know what modes you are in. The Program name is



Yamaha Parametric Room Acoustic Optimizer (YPAO)

- 1) Speaker Connections**
Checks for missing connections and subwoofer phase control (here the right surround speaker is not connected).
- 2) Speaker Distance**
Measures speaker distances from the listening point and corrects for differences down to 5cm.
- 3) Speaker Size**
Checks speaker sizes (large or small) and subwoofer crossover frequency.

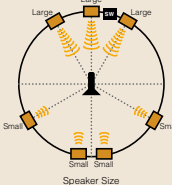
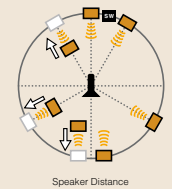
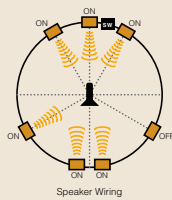

- 4) Speaker Frequency Response**
Measures and optimizes each speaker's frequency response using the 10-band parametric equalizer.

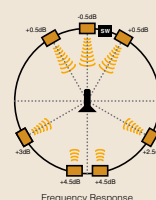

- 5) Sound Pressure Level**
Measures and aligns the sound pressure levels of all speakers.

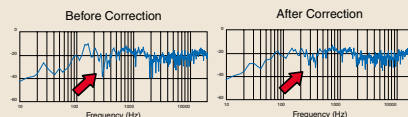
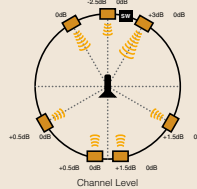

Graphic Equalizer vs. Parametric Equalizer

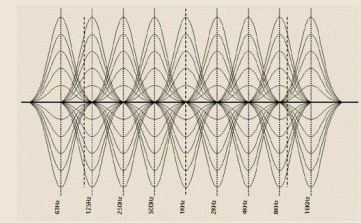

Conventional Graphic Equalizer

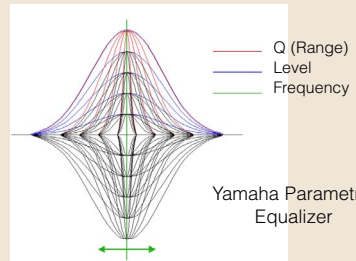

Yamaha Parametric Equalizer

Graphic equalizers adjust only the level, while parametric equalizers adjust level, frequency and Q factor, thus providing more detailed and effective sound equalization.

Setup Operation



displayed, including the word "Night" if the Night Listening mode is selected. Six sound field modes including Quad-Field and Tri-Field are also indicated.

An Extensive Range of Useful Menus

The RX-Z9 gives you extensive control over audio and operational modes through a selection of parameters that can be adjusted from the on-screen menus. The Basic modes are Setup and Speaker Level, while the Sound modes feature a 9-Band Center Graphic Equalizer, Speaker Set, Speaker Distance, LFE Level, Dynamic Range and Headphone Tone Control. There are also Input modes and Options. All of these parameters can be selected and adjusted from either the front panel or the remote control.

Ideal for Use in Custom Installations

The RX-Z9 has numerous features designed to facilitate use in custom, multi-room installations. These include Zone 2 optical digital, video (inc. S-Video) and audio output for multi-room control capability, speaker A/B selection, an RS-232C interface with extended IR code for two-way communication, two trigger outputs, an IR port and a Zone 2 remote control unit.

A/V Rec Out Selector with Zone 2 Selector

The Rec Out Selector lets you choose which source you want to record. As you are recording, you can listen to that source or to the source selected by the Input Selector. The Rec Out Selector

also functions as a Zone 2 Selector.

HDTV (720p/1080i) Compatible Component Video Out

Frequency response of Component Video Monitor Out signal is DC – 200MHz, making it compatible with HDTV monitors.

Subwoofer Crossover Selection

The RX-Z9 provides a choice of nine subwoofer crossover frequencies: 40, 60, 80, 90, 100, 110, 120, 160 and 200 Hz. In addition to providing a wider range than other receivers, the steps from 80 to 120 Hz are only 10 Hz apart for more precise selection. This choice of crossovers lets you "fine-tune" the audio system by selecting the optimum frequency to maximize receiver/speaker efficiency and also ensures best performance from a wider variety of speakers (small to large).

Fixed and Assignable Terminals

Yamaha offers terminals that can be either independently assigned to sources or defaulted to fixed settings.

9-Band Graphic Equalizer

In addition to the many audio parameters that can be adjusted, the RX-Z9 provides an even greater degree of sound field control with the inclusion of a Graphic Equalizer. This lets you finely "tune" the overall balance of the sound field to achieve the optimal imaging for movie sound.

Tuner Section Features High Quality, Easy Operation

In addition to utilizing a Direct PLL IF Count Synthesizer Tuning system, the RX-Z9 also makes station selection easy. Users can preset as many as 40 stations for instant one-touch tuning, and with each one the tuning mode

(auto or mono) is also memorized.

Auto FM Station Memory will automatically preset the 40 strongest stations on the dial. The Preset Editing function can then be used to rearrange them into groups.

Direct Access Remote Unit

The remote control can "learn" the functions of other components, so you can use it as a single remote for the entire system. It has a large memory capacity and comes pre-encoded with many television and component codes. The buttons in the component control area have different functions for each type of component, selected by pressing the input button. The input name is shown in the LCD window, and you can change each name. Frequently used functions are easily accessible on the front, while others are located under the sliding panel. Finally, 15 different macros (multi-command) functions can be programmed.

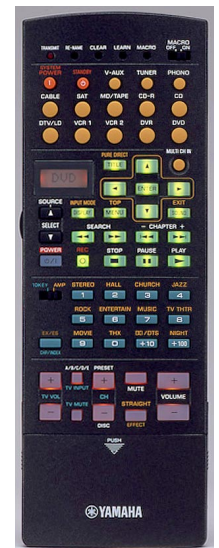

Other Notable Features

- Large Rotary Encoder Input Selector
- Analog Mixdown: Speaker: Configuration for analog multi-channel input (C/SL/SR/SBL/SBR/Subwoofer/None)
- Level Setting for Each input
- S-Video 1/2 Wide Selective Signal Compatibility
- Sleep Timer

Sophisticated Video Technology and Complete Digital Video Conversion

Designed for use in high-end home theater systems, the RX-Z9 offers the highest level of video performance.

Digital Component Video Up Conversion

Full up/down video conversion (component, S-Video, composite) is offered, meaning that you simply use the best possible cable between the receiver and the TV, and then whatever the source is, you are assured of getting the highest possible quality.

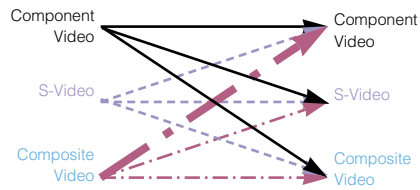

Progressive Scan Video Output

Progressive Scan Video Output and Other Video Technologies
 The RX-Z9 is the first receiver to provide Progressive Scan Video Output, for use with high definition monitors. The progressive circuit is an Area Adaptive 3:2 Pull-Down Detection type, and gives you the benefit of progressive scanning even if your DVD player does not have it. Other video technologies include a Time Base Corrector, 108MHz/10-bit Video D/A Conversion, Motion Adaptive Noise Reduction, Close Color Suppression, Aspect Ratio Conversion and Faroudja's TrueLife Enhancer circuitry.

DCDi Processing

The RX-Z9 is also the first receiver to offer Faroudja's DCDi Processing, which is selectable and ensures that images are smooth and natural, without staircasing or jaggies.

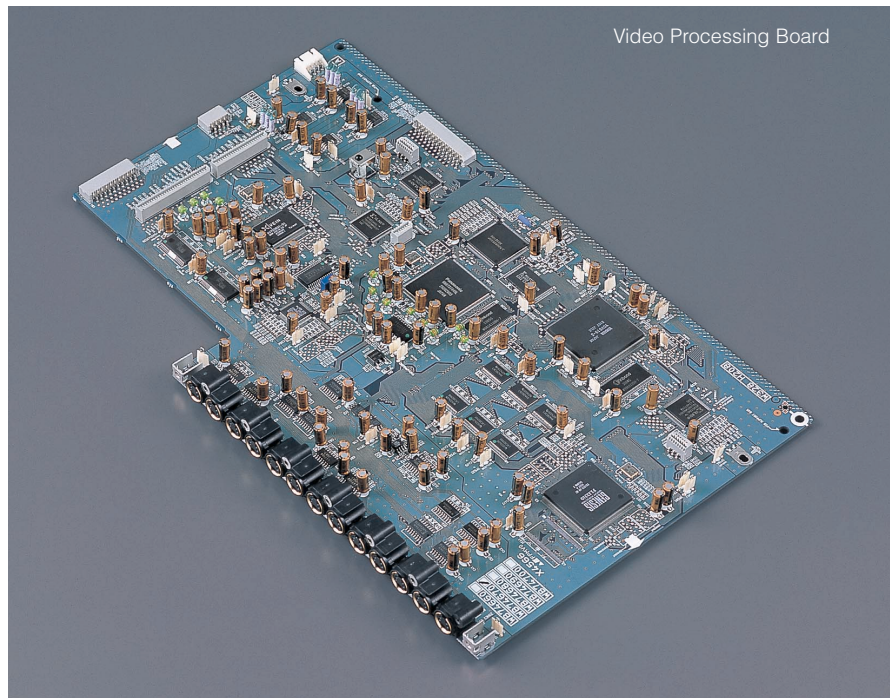

Before TrueLife Enhancer (Left) vs. After TrueLife Enhancer (Right)

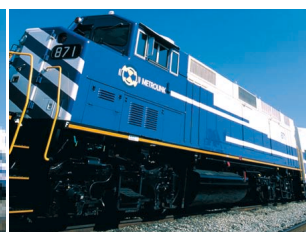

DCDi Off (Left) vs. DCDi On (Right)



Without Film Mode (Left) vs. With Film Mode (Right)

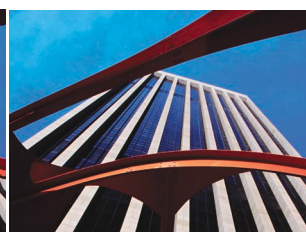

Time Base Corrector Off vs. Time Base Corrector On (Right)

Versatile, Extensive Connections

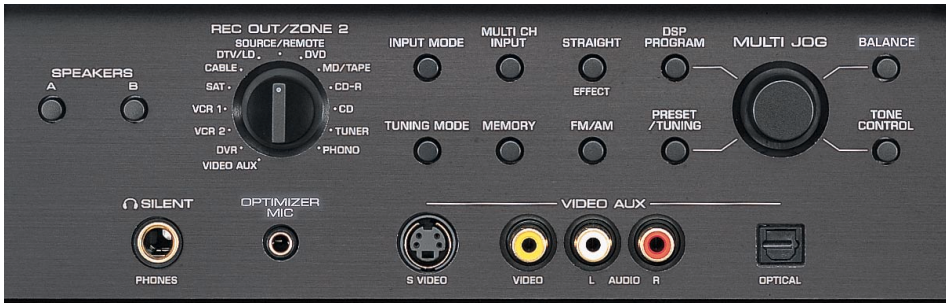

Oil-Damped Hidden Control Panel

Front Panel Aux Input Terminals with Optical Digital and S-Video Terminals: Auxiliary terminals with optical digital input make it convenient to connect a digital game machine so you can enjoy DVD games and movies.

Gold-Plated-Extruded Gigantic Speaker Terminals (Banana-Plug Compatible, All Terminals)

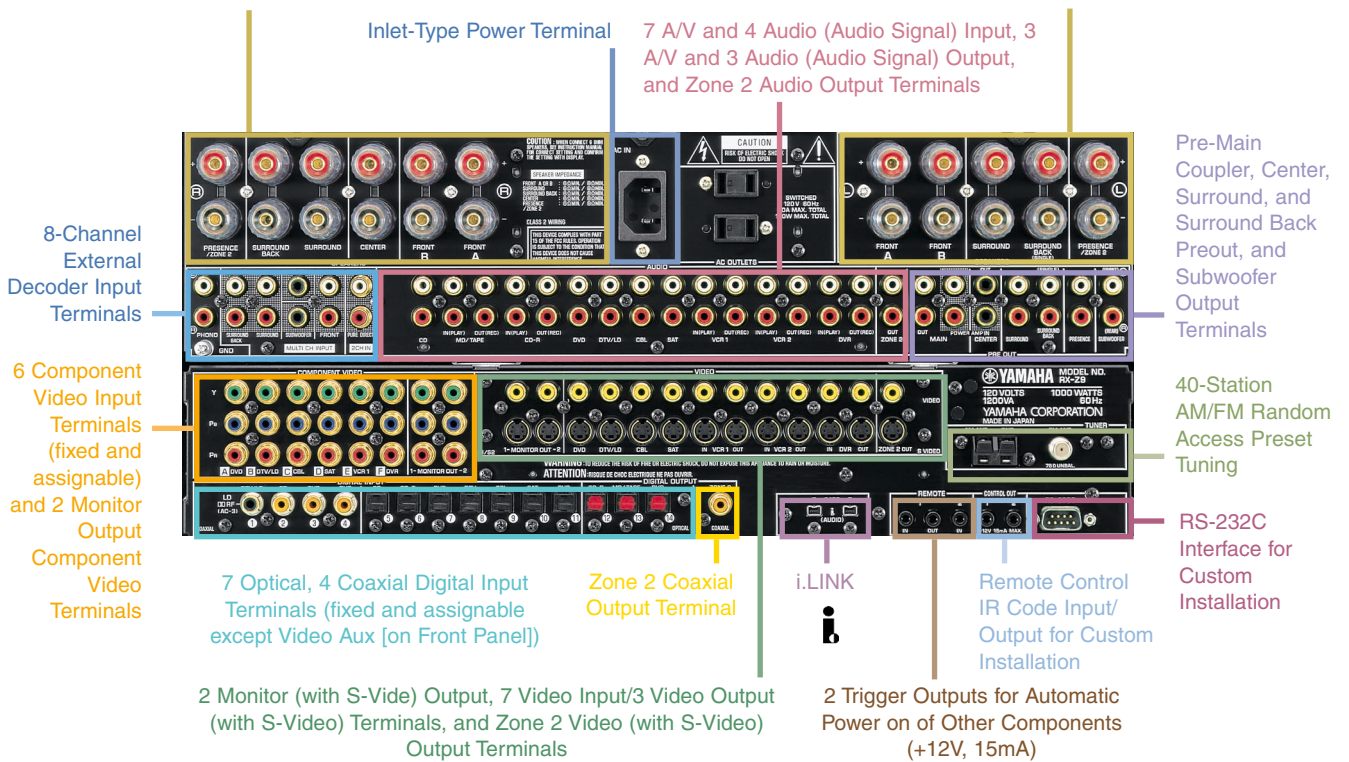

RX-Z9 Inputs and Outputs

	Analog		Digital				Composite		Video S Video		Component Video	
	In	Out	In	Out	In	Out	In	Out	In	Out	In	Out
PHONO	■											
CD	■		■		■							
MD/TAPE	■	■	■		■		■	■				
CD-R	■	■	■		■		■	■				
DVD	■		■		■		■				■	
DTV	■		■		■		■					■
DTV/LD			●									
CBL	■		■		■							■
SAT	■		■		■		■					■
VCR 1	■	■	■		■		■	■		■	■	
VCR 2	■		■		■		■	■		■	■	
DVR	■	■	■		■		■	■		■	■	
Video Aux	■						■					
Monitor Out 1												■*
Monitor Out 2												■*
ZONE 2				■								
Multi-Ch	■											
2-Ch	■											

Fixed (■), Fixed/Assignable (■) and Assignable (●) Terminals.
RF (AC-3) terminal for LD input (●) is assignable as coaxial digital terminal.

■*: HDTV (720p/1080i) Compatible Component Video Out

■: Complete Interactive Video Conversion

Yamaha offers terminals that can be either independently assigned to sources or defaulted to fixed settings.

RX-Z9 Main Specifications

AUDIO SECTION

Minimum RMS Output Power (8 ohms, 20—20,000 Hz, 0.015% THD)		
Front Channels		170 W + 170 W
Center Channel		170 W
Surround Channels		170 W + 170 W
Surround Back Channel		170 W + 170 W
Presence Channel		50 W + 50 W
High Dynamic Power, Low-Impedance Drive Capability		
Dynamic Power/Channel	8 ohms	210 W
	6 ohms	260 W
	4 ohms	340 W
	2 ohms	580 W
Linear Damping		
Damping Factor (8 ohms, 20—20,000 Hz)		200 (speaker A)
Input Sensitivity/Impedance		
	Phono (MM)	2.5 mV/47 k-ohms
	CD	200 mV/47 k-ohms
Frequency Response		
		10—100,000 Hz +0, -3 dB
Total Harmonic Distortion (20—20,000 Hz)		
	CD (Front/Center In, Sp Out, 85 W/8 ohms)	0.005%
Signal-to-Noise Ratio (CD, 250 mV)		
		100 dB
Speaker/Headphone Tone Control Characteristics (Front/Center/Subwoofer)		
Bass	Boost/Cut	+6 dB/-6 dB (50 Hz)
	Turnover Frequency	125 Hz/350 Hz/500 Hz
Treble	Boost/Cut	+6 dB/-6 dB (20 kHz)
	Turnover Frequency	2.5 kHz/3.5 kHz/8 kHz
Manual Graphic Equalizer (Front/Center/Surround/Surround Back/Presence)		
	f=63 Hz, 125 Hz, 250 Hz, 500 Hz, 1 kHz, 2 kHz, 4 kHz, 8 kHz and 16 kHz	
	Q=1.2	Step=0.5 +6 dB/-6 dB
YPAO (Yamaha Parametric Room Acoustic Optimizer)		
	f=63 Hz — 16 kHz	+6 dB/-20 dB, 10 bands
Crossover Characteristics (Subwoofer Out)		
		40, 60, 80, 90, 100, 110, 120, 160 and 200 Hz

Cinema Equalizer

High Shaving Filter	Frequency	1,000 — 12,700 Hz
	Boost/Cut	+6 dB/-9 dB
Parametric Equalizer	Frequency	1,000 — 12,700 Hz
	Boost/Cut	+6 dB/-9 dB

VIDEO SECTION

Video Signal Level		1 Vp-p/75 ohms
S-Video Signal Level	Y	1 Vp-p/75 ohms
	C	0.286 Vp-p/75 ohms
Component Video Signal Level		Y
	Pb/Cb, Pr/Cr	0.7 Vp-p/75 ohms
Signal-to-Noise Ratio		50 dB
Monitor Out Frequency Response		
	Composite/S-Video Signal	5 Hz—10MHz -3 dB
	Component video Signal	5 Hz—100MHz -3 dB

TUNER SECTION

FM 50dB Quieting Sensitivity (1 kHz, 100% Modulation)		
	Mono	2 µV (17.3 dBf)
	Stereo	25 µV (39.2 dBf)
FM Selectivity	400 kHz	70 dB
FM Signal-to-Noise Ratio	Mono/Stereo	76 dB/70 dB
FM Frequency Response	20—15,000 Hz	+0.5/-2 dB

GENERAL

Standby Power Consumption		Less than 1 W
Dimensions (W x H x D)		435 x 211 x 471 mm
		17-1/8" x 8-5/16" x 18-7/16"
Weight		30 kg; 66.1 lbs.



Yamaha's unique technology for the creation of sound fields is capable of powerfully reproducing the three-dimensional environment that movie sound engineers aim to convey, in any audio format from monaural to the latest 6.1-channel digital surround. It is compatible with DVD and all other A/V sources.

Yamaha CINEMA DSP technology has received a patent in the U.S. (Patent No. 5,261,005).

"Silent" is a trademark of Yamaha Corporation.

- Dolby Digital and Double D are trademarks of Dolby Laboratories Corporation.
- DTS is a trademark of DTS Technology LLC.
- Burr-Brown products are trademarks of Texas Instruments, Inc.
- "DCDI" is a trademark of Faroudja, a division of Genesis Microchip Inc.
- NSV is a trademark of Analog Device inc
- Product designs and specifications are subject to change without notice.

For details please contact:

Visit us at our website:
<http://www.yamaha.co.jp/>



CREATING 'KANDO' TOGETHER

YAMAHA CORPORATION
 P.O. Box 1, Hamamatsu, Japan

PI0001894-RXZ9 U@703